



INNOCENTI

TROLLEY  
F76









# Italian Design

GEMELLI Design Centre  
FABRIZIO PEPE Design Director

- 🇮🇹 Ogni curva, ogni dettaglio riflette l'essenza dell'estetica italiana, con un equilibrio perfetto tra forma e funzione. Ogni linea, ogni proporzione è studiata con cura maniacale per creare una vettura che non solo si distingue per la sua bellezza, ma anche per la sua capacità di suscitare emozioni intense. Con la Trolley, il design italiano raggiunge nuove vette di eccellenza, regalando un'esperienza di guida che va oltre il semplice trasporto.
- 🇫🇷 Chaque courbe, chaque détail reflète l'essence de l'esthétique italienne, avec un équilibre parfait entre forme et fonction. Chaque ligne, chaque proportion est étudiée avec un soin obsessionnel pour créer une voiture qui se distingue non seulement par sa beauté, mais aussi par sa capacité à susciter des émotions intenses. Avec le Trolley, le design italien atteint de nouveaux sommets l'excellence, offrant une expérience de conduite qui va au-delà du transport simple.
- 🇬🇧 Every curve, every detail reflects the essence of Italian aesthetics, with a perfect balance between form and function. Every line, every proportion is studied with obsessive care to create a car that not only stands out for its beauty, but also for its ability to arouse intense emotions. With the Trolley, Italian design reaches new heights of excellence, offering a driving experience that goes beyond simple transportation.



# L6 L7 BUSINESS

## Trolley L6/L7 Business: L'innovazione del Trasporto Urbano

-  La nuova microcar Innocenti, erede di una lunga tradizione di eccellenza automobilistica italiana, incarna l'essenza dell'innovazione e dello stile contemporaneo. Concepita per affrontare le sfide della mobilità urbana del XXI secolo, questa vettura compatta e maneggevole offre un mix irresistibile di praticità, prestazioni ecologiche e design distintivo.
-  La nouvelle microcar Innocenti, héritière d'une longue tradition d'excellence automobile italienne, incarne l'essence de l'innovation et du style contemporain. Conçue pour répondre aux défis de la mobilité urbaine du 21e siècle, cette voiture compacte et maniable offre un mélange irrésistible de praticité, de performances écologiques et de design distinctif.
-  The new Innocenti microcar, heir to a long tradition of Italian automotive excellence, embodies the essence of innovation and contemporary style. Conceived to meet the challenges of 21st century urban mobility, this compact and easy-to-handle car offers an irresistible mix of practicality, eco-friendly performance and distinctive design.





INNOGENTI





🇮🇹 Ogni dettaglio della microcar Innocenti riflette l'impegno dell'azienda per la sostenibilità e l'innovazione. Il suo motore eco-friendly assicura una guida efficiente e a emissioni zero, rendendola ideale per contribuire a una città più pulita e vivibile.

🇫🇷 Chaque détail de la microvoiture Innocenti reflète l'engagement de l'entreprise en faveur de la durabilité et de l'innovation. Son moteur écologique garantit une conduite efficace et zéro émission, ce qui le rend idéal pour contribuer à une ville plus propre et plus agréable à vivre.

🇬🇧 Every detail of the microcar Innocenti reflects the company's commitment to sustainability and innovation. Its eco-friendly engine ensures efficient and zero-emission driving, making it ideal for contributing to a cleaner and more livable city.







 Con la sua combinazione di prestazioni ecologiche, design raffinato e praticità urbana, la microcar Innocenti si distingue come la scelta perfetta per chi desidera un'alternativa intelligente e sostenibile per muoversi in città. Abbraccia la tradizione di innovazione e stile che ha reso celebre il marchio Innocenti, offrendo al contempo una visione audace del futuro della mobilità urbana.

 Avec sa combinaison de performances écologiques, de design raffiné et de praticité urbaine, la microvoiture Innocenti s'impose comme le choix parfait pour ceux qui recherchent une alternative intelligente et durable pour se déplacer en ville. Il embrasse la tradition d'innovation et de style qui a fait la renommée de la marque Innocenti, tout en offrant une vision audacieuse de l'avenir de la mobilité urbaine.

 With its combination of ecological performance, design refined and urban practicality, the Innocenti microcar stands out as the perfect choice for those who want an intelligent alternative and sustainable for getting around the city. It embraces the tradition of innovation and style that has made the Innocenti brand famous, while offering a bold vision of the future of urban mobility.











 Gli interni della L6/L7 Business, ha delle linee ricercate e un design giovanile, essa rappresenta a pieno il riassunto dello stile contemporaneo.

 L'intérieur du L6/L7 Business, il possède des lignes épurées et un design jeune, il représente pleinement le résumé du style contemporain.

 The interior of the L6/L7 Business, it has refined lines and a design youthful, it fully represents the summary of contemporary style.





 Nonostante le sue dimensioni compatte, l'abitacolo della microcar Innocenti è sorprendentemente spazioso e confortevole, offrendo un'esperienza di guida piacevole e rilassante anche nei contesti urbani più frenetici.

 Malgré ses dimensions compactes, l'habitacle de la microvoiture Innocenti est étonnamment spacieux et confortable, offrant une expérience de conduite agréable et relaxante même dans les contextes urbains les plus mouvementés.

 Despite his compact dimensions, the cockpit of the Innocenti microcar is surprisingly spacious and comfortable, offering a pleasant and relaxing driving experience even in the most hectic urban contexts.







# L6

# L7

# SPORT

## Trolley L6/L7 Sport: L'Adrenalina della Città

-  La Trolley Sport, con i suoi passaruota allargati e le finiture in carbonio e alcantara negli interni, rappresenta la scelta ideale per coloro che desiderano un tocco di sportività e stile nella propria vettura. Il suo design accattivante e le prestazioni dinamiche la rendono una compagna di guida perfetta.
-  Le Sport Trolley, avec ses passages de roues élargis et ses finitions intérieures en carbone et alcantara, représente le choix idéal pour ceux qui souhaitent une touche de sportivité et de style dans leur véhicule. Son design attrayant et ses performances dynamiques en font un compagnon de route parfait.
-  The Sport Trolley, with its widened wheel arches and carbon and alcantara interior finishes, represents the ideal choice for those who want a touch of sportiness and style in their vehicle. Its attractive design and dynamic performance make it a driving companion perfect.









La Trolley Sport cattura l'attenzione con il suo design aggressivo e dinamico. I passaruota allargati conferiscono alla vettura una presenza straordinaria sulla strada, mentre le linee affilate e i dettagli estetici decorano la vettura.

Le Sport Trolley capte l'attention avec son design agressif et dynamique. Les passages de roues évasés donnent de la présence à la voiture extraordinaire sur la route, tandis que les lignes nettes et les détails esthétiques décorer la voiture.

The Sport Trolley captures attention with its aggressive and dynamic design. The flared wheel arches give the car presence extraordinary on the road, while the sharp lines and aesthetic details decorate the car.







🇮🇹 La Trolley Sport sfoggia un design che cattura l'immaginazione, con linee audaci e proporzioni dinamiche che suggeriscono potenza e praticità.

🇫🇷 Le Sport Trolley présente un design qui captive l'imagination, avec des lignes audacieuses et des proportions dynamiques qui suggèrent puissance et praticité.

🇬🇧 The Sport Trolley features a design that captures the imagination, with bold lines and dynamic proportions that suggest power and practicality.







INNOCENTI

12:39  
LTE

Phone Music Maps Messages  
Now Playing Podcasts Audiobooks Audible

ENGINE  
START  
STOP



🇮🇹 Le finiture in carbonio e alcantara trasmettono sono pensate per esaltare l'animo sportivo, mentre i sedili avvolgenti vi accompagneranno in ogni viaggio.

🇫🇷 Les finitions carbone et Alcantara sont conçues pour sublimer l'âme sportive, tandis que les sièges enveloppants ils vous accompagneront à chaque voyage.

🇬🇧 The carbon and Alcantara finishes are designed to enhance the sporty soul, while the enveloping seats will accompany you on every trip.









# L6

## EASY

### Trolley L6 Easy: L'Efficienza Urbana Moderna

- Un'eccellenza accessibile, con finiture estetiche che ne esaltano il design. Un design moderno a un prezzo conveniente, perfetta per chi cerca la perfezione e la funzionalità senza sacrifici. La Trolley L6 Easy è l'incarnazione della praticità a un prezzo accessibile, progettata per soddisfare le esigenze dei guidatori che cercano funzionalità e comodità senza compromessi.
- Une excellence accessible, avec des finitions esthétiques qui mettent en valeur le design. Un design moderne à un prix abordable, parfait pour ceux qui recherchent la perfection et la fonctionnalité sans sacrifices. Le Trolley L6 Easy est l'incarnation de la praticité à un prix abordable, conçu pour répondre aux besoins des conducteurs à la recherche de fonctionnalité et de confort sans compromis.
- An accessible excellence, with aesthetic finishes that enhance the design. A modern design at an affordable price, perfect for those seeking perfection and functionality without sacrifices. The L6 Easy Trolley is the embodiment of practicality at an affordable price, designed for meet the needs of drivers looking for functionality and comfort without compromise.









Il design della Trolley L6 Easy è una sinfonia di linee pulite e proporzioni armoniose, che si fondono per creare un'immagine di micromobilità senza tempo.

La conception du Le trolley L6 Easy est une symphonie de lignes propre et proportions harmonieux, oui fusionner pour créer une image de micromobilité intemporelle.

The design of the Trolley L6 Easy is a symphony of clean lines and harmonious proportions, it merges to create an image of timeless micromobility.







 La silhouette compatta conferisce alla vettura un aspetto moderno e dinamico, mentre i dettagli accattivanti aggiungono un tocco di divertimento alla sua presenza sulla strada.

 La silhouette compacte confère à la voiture une apparence moderne et dynamique, tandis que les détails accrocheurs ajoutent une touche de amusant dans sa présence sur la route.

 The compact silhouette gives the car a modern and dynamic look, while the details eye-catching add a touch of fun in its presence on the road.









Gli interni della Trolley L6 Easy sono un'espressione di praticità e funzionalità, progettati per offrire un ambiente accogliente e giovanile che riflette il l'animo della vettura. 

Les intérieurs du L6 Easy Trolley sont une expression de praticité et de fonctionnalité, conçus pour offrir un environnement accueillant et jeune qui reflète l'âme de la voiture. 

The interiors of the L6 Easy Trolley are an expression of practicality and functionality, designed to offer a welcoming and youthful environment that reflects the soul of the car. 



 I sedili confortevoli e avvolgenti della Trolley L6 Easy vi invitano a fare lunghe percorrenze senza affaticarvi, offrendo un sostegno ottimale durante ogni viaggio. Lo spazioso abitacolo offre ampio spazio per passeggeri e bagagli, garantendo una comodità senza paragoni.

 Les sièges confortables et enveloppants du L6 Easy Trolley vous invitent aux longs voyages sans me fatiguer, offrir un soutien optimal à chaque voyage. Le spacieux l'intérieur offre de l'espace espace pour les passagers et les bagages, assurant un confort inégalé.

 The comfortable and enveloping seats of the L6 Easy Trolley invite you to take long journeys without getting tired, offering support optimal during every trip. The spacious interior offers spacious space for passengers and luggage, guaranteeing unparalleled comfort.





 Con un equilibrio armonioso tra design italiano e funzionalità moderna, questa vettura offre un ambiente di guida che non solo soddisfa, ma supera le aspettative di ogni guidatore.

 Avec un équilibre harmonieux entre le design italien et la fonctionnalité moderne, ce la voiture offre un un environnement de conduite qui non seulement répond, mais dépasse les attentes de chaque conducteur.

 With a harmonious balance between Italian design and modern functionality, this car offers a driving environment that not only meets, but exceeds every driver's expectations.





# L7 CARGO

## Trolley L7 Cargo: L'Efficienza in Movimento

- La Trolley Cargo si distingue per la sua versatilità e praticità. Con i vetri posteriori oscurati e un ampio vano di carico per i pacchi, è perfetta per le esigenze aziendali. Il fascione laterale personalizzabile consente di inserire lo sponsor della propria azienda, aggiungendo un tocco personalizzato alla vettura.
- Le Trolley Cargo se distingue par sa polyvalence et sa praticité. Avec des vitres arrière teintées et un grand espace de chargement pour les colis, il est parfait pour les besoins professionnels. La bande latérale personnalisable vous permet d'insérer le sponsor de votre entreprise, ajoutant ainsi une touche personnalisée à la voiture.
- The Cargo Trolley stands out for its versatility and practicality. With tinted rear windows and a large cargo area for parcels, it's perfect for business needs. The customizable side band allows you to insert your company sponsor, adding a personalized touch to the car.





TROLLEY

DELIVERY





🇮🇹 Con linee pulite e proporzioni compatte, questa vettura si muove agilmente tra il traffico cittadino, mentre i vetri posteriori oscurati proteggono il carico e offrono privacy durante le consegne.

🇫🇷 Avec des lignes épurées et des proportions compactes, cette voiture se déplace avec agilité dans la circulation urbaine, tandis que les vitres arrière teintées protègent le chargement et offrent de l'intimité pendant les livraisons.

🇬🇧 With clean lines and compact proportions, this car moves easily through city traffic, while the rear windows are tinted they protect cargo and offer privacy during deliveries.







INNOCENTI

DELIVERY



 La Trolley Cargo può essere personalizzata per soddisfare le esigenze specifiche della tua attività. Con un ampio vano di carico e la possibilità di personalizzare il fascione laterale, puoi adattare la vettura alle esigenze del tuo business, garantendo consegne puntuali e professionali ad ogni cliente.

 Le Trolley Cargo peut être personnalisé pour répondre aux besoins spécifiques de votre entreprise. Avec un grand compartiment de chargement et la possibilité de personnaliser le panneau latéral, vous pouvez adapter la voiture aux besoins de votre entreprise, garantissant des livraisons ponctuelles et professionnelles à chaque client.

 The Cargo Trolley can be customized for meet the specific needs of your business. With a large cargo area and the ability to customize the side fascia, you can adapt the car to needs of your business, guaranteeing punctual and professional deliveries to each customer.







INNOCENTI

Phone Music Maps Messages

12:39 LTE

Now Playing Podcasts Audiobooks Audible

ENGINE  
START  
STOP



 Gli interni della Trolley Cargo sono uno spazio di lavoro ben organizzato, pensato per massimizzare la tua produttività durante le consegne.

 L'intérieur du Trolley Cargo est un espace de travail bien organisé, conçu pour maximiser votre productivité lors des livraisons.

 The interiors of Trolley Cargo are a well-organized workspace, designed to maximize your productivity during deliveries.







Con un layout che predilige la praticità, hai tutto lo spazio di cui hai bisogno per organizzare i tuoi pacchi in modo efficiente, mentre i sedili confortevoli e il sistema di climatizzazione regolabile assicurano un viaggio comodo in qualsiasi condizione.



Avec un aménagement privilégiant la praticité, vous disposez de tout l'espace nécessaire pour organiser efficacement vos colis, tandis que les sièges confortables et le Système de conditionnement d'air réglable pour garantir une conduite confortable dans toutes les conditions.



With a layout that favors practicality, you have all the space you need to organize your packages efficiently, while the comfortable seats and the air conditioning system adjustable ensure a comfortable ride in any condition.







# L6

## SCHEDA TECNICA

### INFORMAZIONI DI BASE

 N.ro Posti: 2  
Autonomia: 120 Km  
Potenza Nominale: 4 kw  
Tempo di Ricarica: 5h  
Trazione: **Posteriore**

 Nombre de places : 2  
Autonomie : 120 km  
Puissance nominale : 4 kW  
Temps de charge : 5h  
À traction : **Arrière**

 No. of places: 2  
Autonomy: 120 km  
Nominal power: 4 kw  
Charging time: 5h  
Traction: **Rear-wheel Drive**





Vehicle code	QC-01
Vehicle type	Light vehicles
Length x Width x Height (mm)	2495x 1295x1590
Wheelbase (mm)	850
FRONT/Rear Wheel distance(mm)	1122
APPROACH/DEPARTURE ANGLE	30°/30°
GVW(kg)	650
Minimumturning radius (m)	4.5
Minimumground clearance (mm)	135
Brake type	Front disc rear disc
Tire specifications	155/50R14
Motor type	Permanent Magnet synchronous motor
Cooling method	Air-cooled
Rated Power(kw)	4
Maximumspeed (km/h)	45
Maximumgrade (%)	25
Full Range (km)	120
Batterytype (*)	LFP
Rated capacity (Ah)	100
Nominal voltage (V)	76.8
Battery pack weight (kg)	75
Batterycapacity (KwH)	7.68
On-board charger (Kw)	1.8 (3.3Kw)
Charging mode	ACslowcharge
Charging time0-100%(h)	5
In-car power supply	220V3KW
Bodystructure	Load-bearing bod
Front suspension type	McPherson independent suspension
Rear suspension type	Integral damping suspension

Drive mode	Rear drive
Transmission	Fixed ratio 8: 1
Steering	steering wheel center mounted
Front combination light source	LED
Daytime traffic light source	LED
Wipers	Intermittent front wiper
Door Lock opening and closing mode	Interior central lock
Start up mode	One button start
Central control screen size	9
multimedia)	Reverse image,Bluetooth, MP3, MP4, radio, USB
Number of USB ports	1
Number of speakers	2
Door and window lifting mode	Electric
Heating and cooling air conditioner	Optional
Number of seating positions	2
Seat cover	Imitation leather
Seat adjustmen	4-way adjustment
Type of seat belt	Three-point
Sun visor	Flip
Charge and discharge times	> 2000
Charging mode	Mode 2/Mode 3
Shift type	Knob
Standing slope function	Anti-slide slope
Energy recovery	Braking Energy Recovery
Parking mode	Parking
Key type	plug-in remote control key
Fault diagnosis	OBD
T-box interface	Reserve (optional)



## DIMENSIONI

-  Con una larghezza di soli 1295 mm, un'altezza di 1590 mm e una lunghezza di 2495 mm, questa vettura è ideale per sfrecciare tra il traffico urbano e trovare parcheggio senza difficoltà.
-  Avec une largeur de seulement 1 295 mm, une hauteur de 1 590 mm et une longueur de 2 495 mm, cette voiture est idéale pour accélérer dans le trafic urbain et trouver une place de stationnement sans difficulté.
-  With a width of only 1295 mm, a height of 1590 mm and a length of 2495 mm, this car is ideal for speeding through urban traffic and finding parking without difficulty.

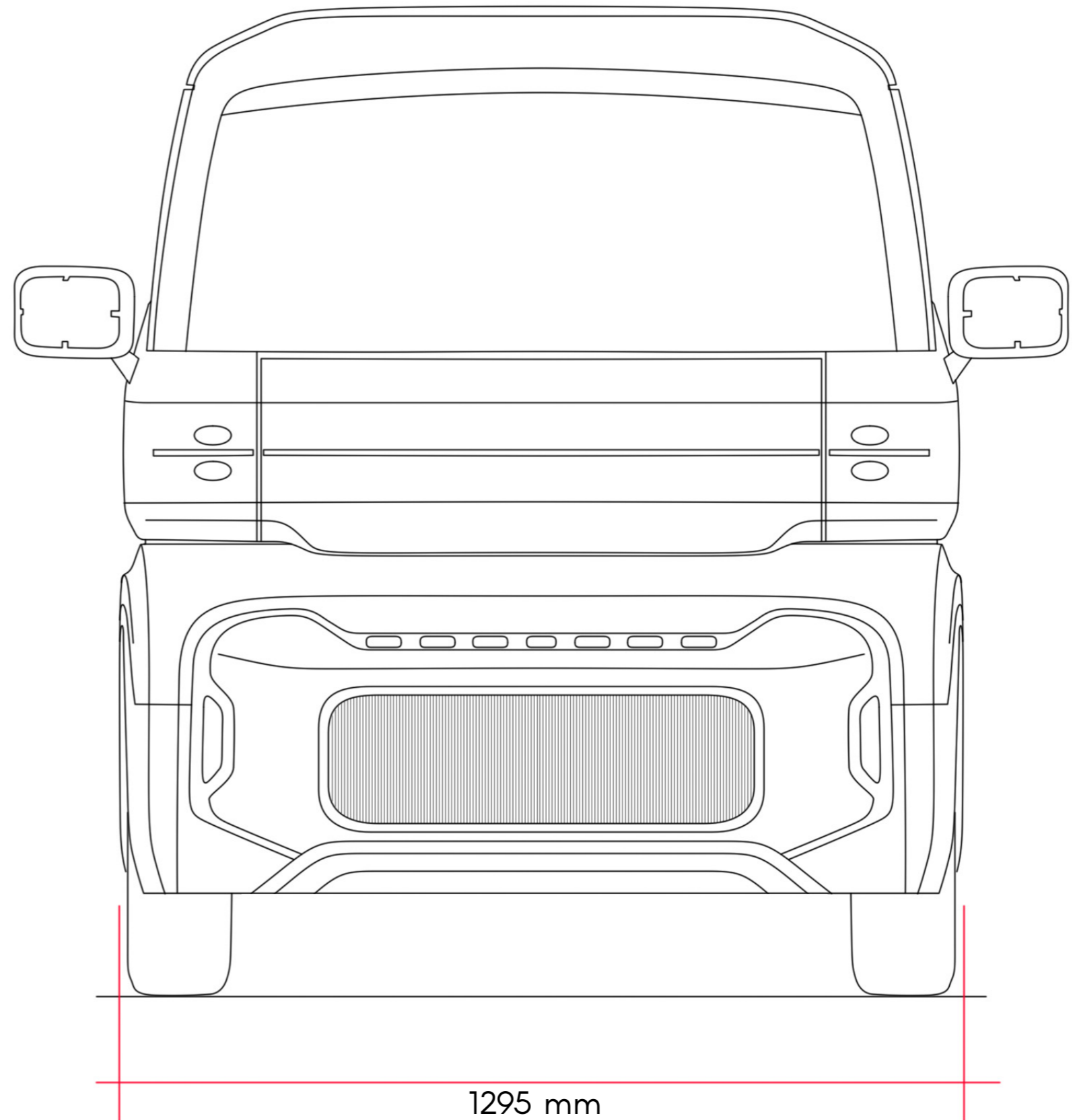



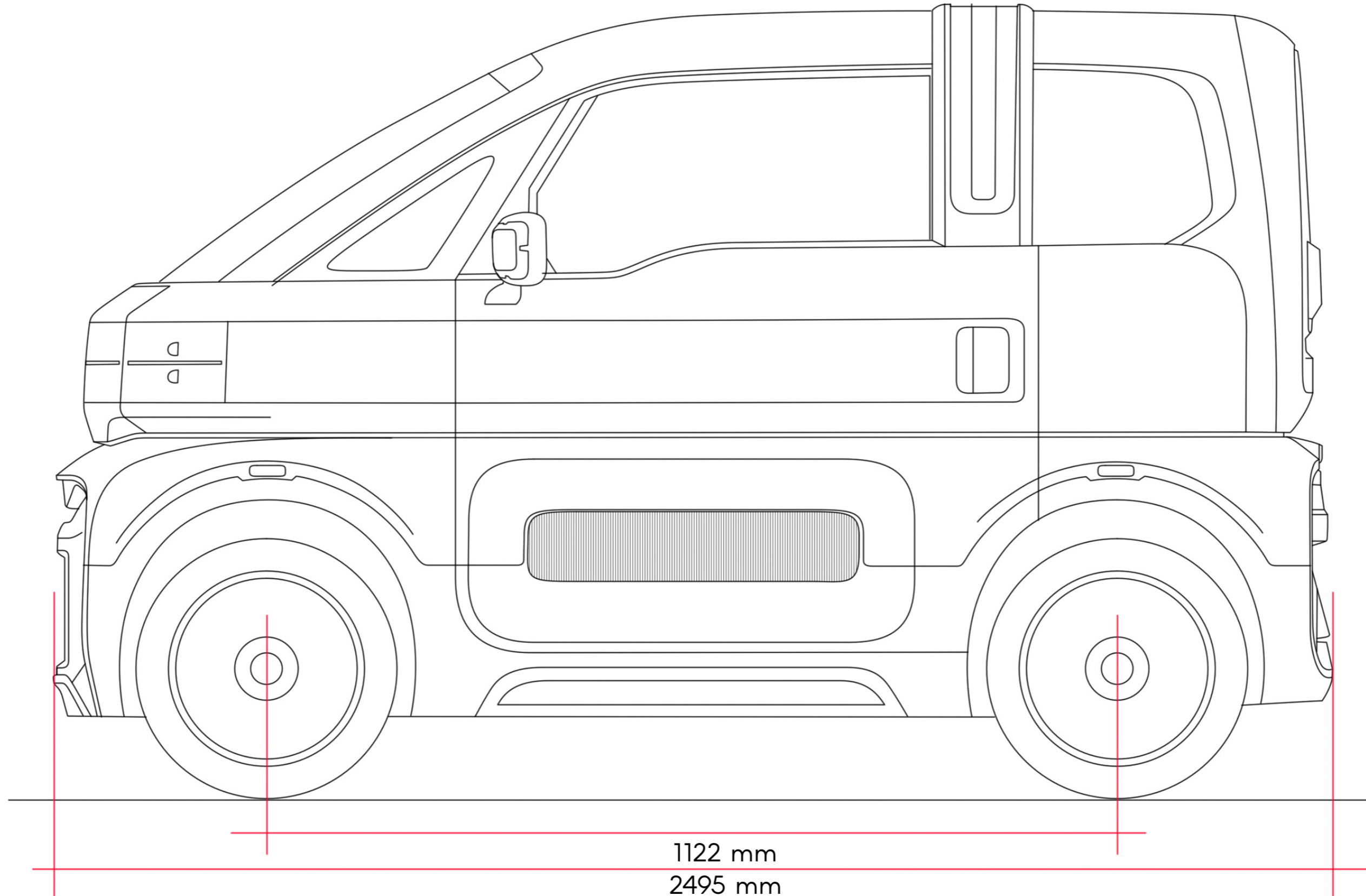

1122 mm  
2495 mm





# L7

## SCHEMA TECNICA

### INFORMAZIONI DI BASE

 N.ro Posti: **2+2**  
Autonomia: **200 Km**  
Velocità Massima: **90 Kh**  
Tempo di Ricarica: **6h**  
Trazione: **Posteriore**

 Nombre de places : **2+2**  
Autonomie : **200 km**  
Vitesse maximale : **90 Kh**  
Temps de charge : **6h**  
À traction : **Arrière**

 No. of places: **2+2**  
Autonomy: **200 km**  
Maximum speed: **90 Kh**  
Charging time: **6h**  
Traction: **Rear-wheel Drive**





Vehicle code	QC-01
Vehicle type	Light vehicles
Length x Width x Height (mm)	2495x 1395x1590
Wheelbase (mm)	850
FRONT/Rear Wheel distance(mm)	1122
APPROACH/DEPARTURE ANGLE	30°/30°
GVW(kg)	875
Minimumturning radius (m)	4.5
Minimumground clearance (mm)	135
Brake type	Front disc rear disc
Tire specifications	155/50R14 165/40R15
Motor type	Permanent Magnet synchronous motor
Cooling method	Air-cooled
Rated Power(kw)	7.5
Maximumspeed (km/h)	90
Maximumgrade (%)	25
Full Range (km)	200
Batterytype (*)	LFP
Rated capacity (Ah)	200
Nominal voltage (V)	76.8
Battery pack weight (kg)	150
Batterycapacity (KwH)	15.36
On-board charger (Kw)	1.8 (3.3Kw)
Charging mode	ACslowcharge
Charging time0-100%(h)	6
In-car power supply	220V3KW
Bodystructure	Load-bearing bod
Front suspension type	McPherson independent suspension
Rear suspension type	Integral damping suspension

Drive mode	Rear drive
Transmission	Fixed ratio 8: 1
Steering	steering wheel center mounted
Front combination light source	LED
Daytime traffic light source	LED
Wipers	Intermittent front wiper
Door Lock opening and closing mode	Interior central lock
Start up mode	One button start
Central control screen size	9
multimedia)	Reverse image,Bluetooth, MP3, MP4, radio, USB
Number of USB ports	1
Number of speakers	2
Door and window lifting mode	Electric
Heating and cooling air conditioner	Optional
Number of seating positions	2+2
Seat cover	Imitation leather
Seat adjustmen	4-way adjustment
Type of seat belt	Three-point
Sun visor	Flip
Charge and discharge times	> 2000
Charging mode	Mode 2/Mode 3
Shift type	Knob
Standing slope function	Anti-slide slope
ABS	Yes
Energy recovery	Braking Energy Recovery
Parking mode	Parking
Key type	plug-in remote control key
Fault diagnosis	OBD
T-box interface	Reserve (optional)



## DIMENSIONI

-  Con una larghezza di soli 1395 mm, un'altezza di 1590 mm e una lunghezza di 2495 mm, questa vettura è ideale per sfrecciare tra il traffico urbano e trovare parcheggio senza difficoltà.
-  Avec une largeur de seulement 1395 mm, une hauteur de 1 590 mm et une longueur de 2 495 mm, cette voiture est idéale pour accélérer dans le trafic urbain et trouver une place de stationnement sans difficulté.
-  With a width of only 1395 mm, a height of 1590 mm and a length of 2495 mm, this car is ideal for speeding through urban traffic and finding parking without difficulty.

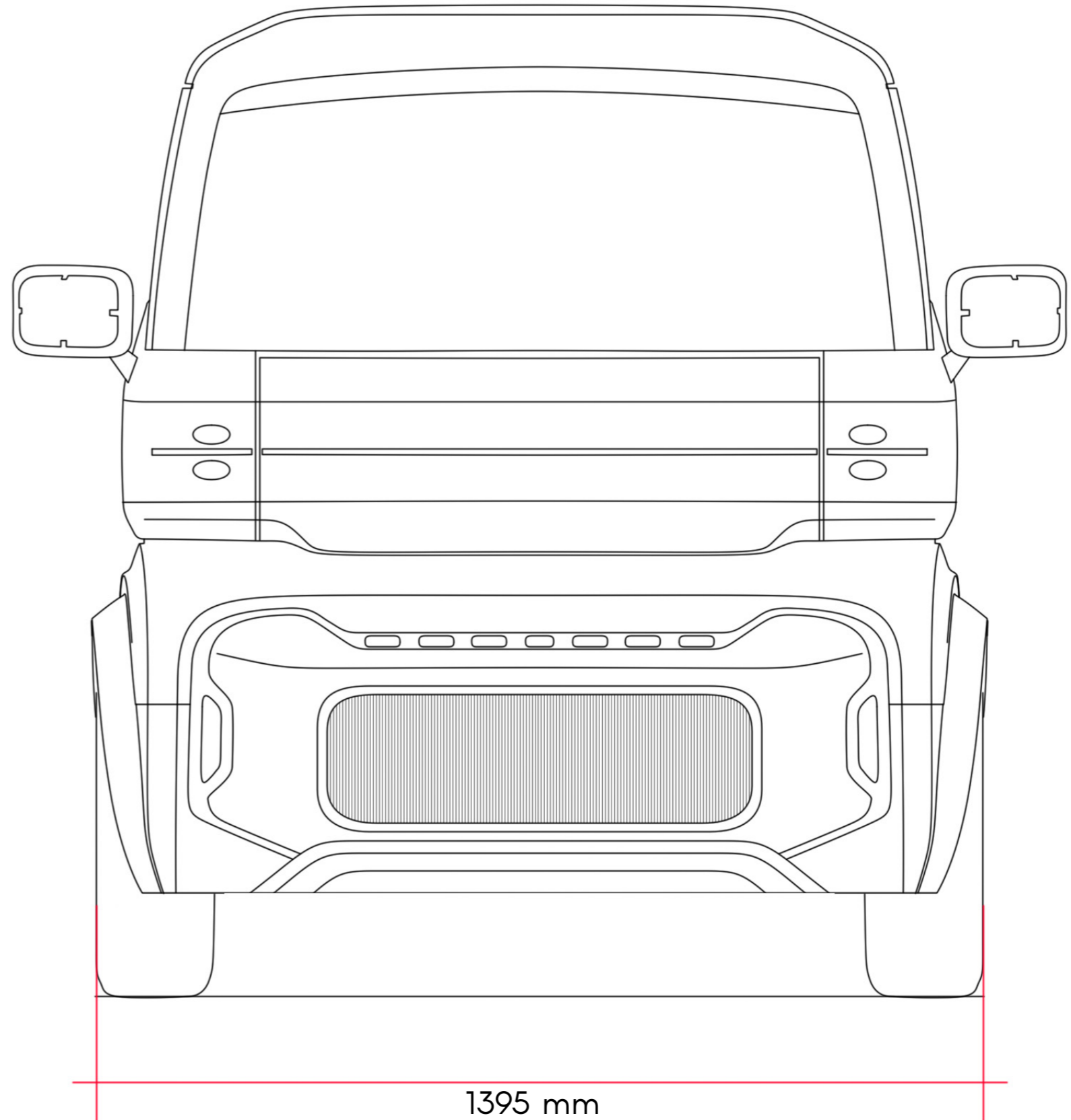



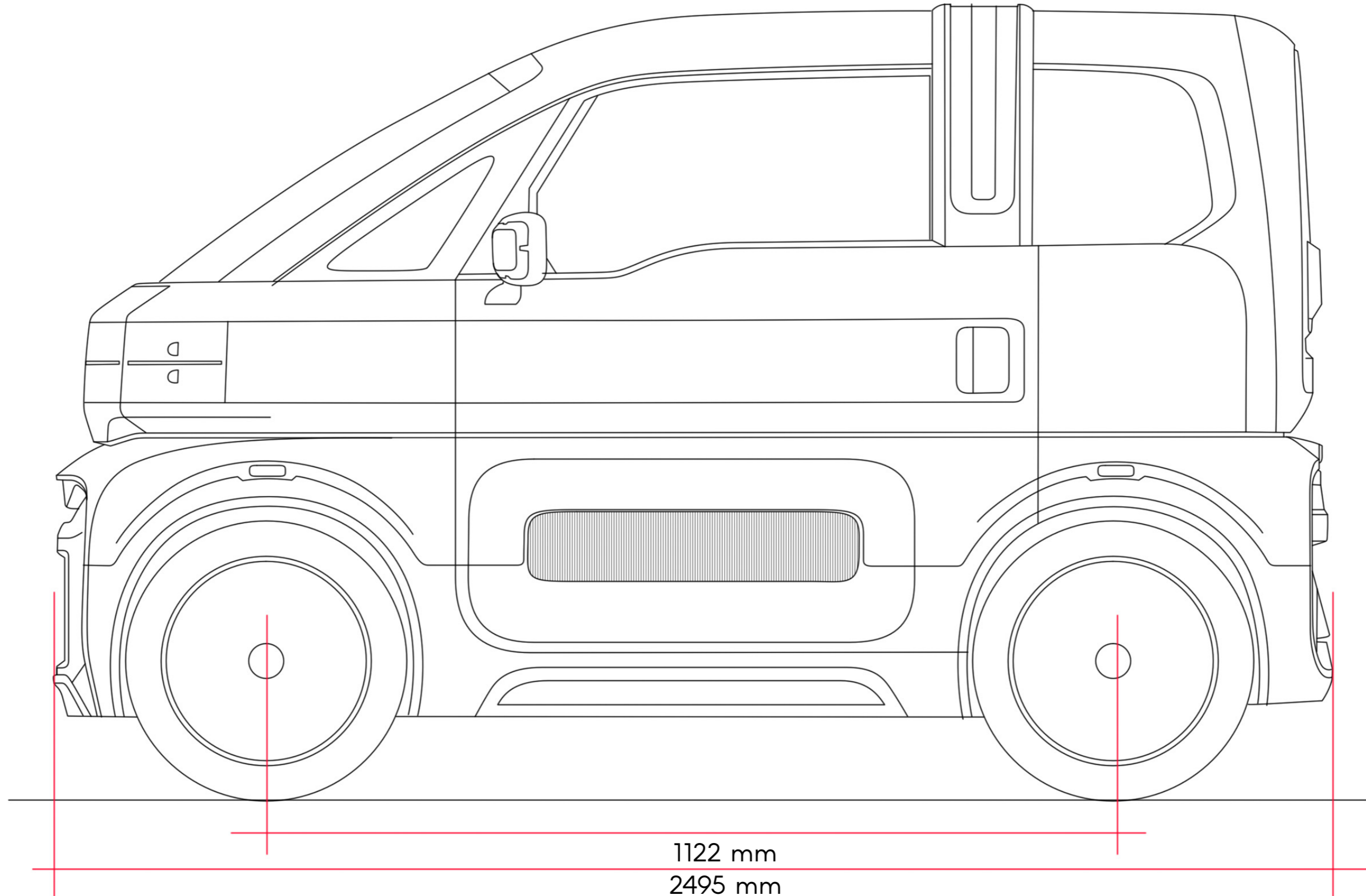

1122 mm  
2495 mm



DIVISIONE AUTOMOBILI E VEICOLI COMMERCIALI WORLDWIDE



Via Giolitti n. 1 , 10123 Torino TO , Italia  
[info@innocenti-italy.com](mailto:info@innocenti-italy.com)